

## Schottky Rectifier, 2 x 30 A

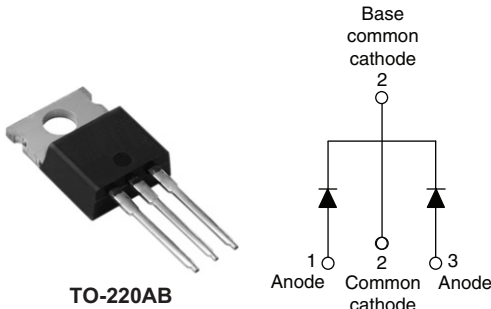

### FEATURES

- 175 °C  $T_J$  operation
- Center tap TO-220 package
- Low forward voltage drop
- High frequency operation
- High purity, high temperature epoxy encapsulation for enhanced mechanical strength and moisture resistance
- Guard ring for enhanced ruggedness and long term reliability
- Lead (Pb)-free ("PbF" suffix)
- Designed and qualified for industrial level

**RoHS\***  
 COMPLIANT

### PRODUCT SUMMARY

$I_{F(AV)}$	2 x 30 A
$V_R$	100 V

### DESCRIPTION

This center tap Schottky rectifier has been optimized for low reverse leakage at high temperature. The proprietary barrier technology allows for reliable operation up to 175 °C junction temperature. Typical applications are in switching power supplies, converters, freewheeling diodes, and reverse battery protection.

### MAJOR RATINGS AND CHARACTERISTICS

SYMBOL	CHARACTERISTICS	VALUES	UNITS
$I_{F(AV)}$	Rectangular waveform (per device)	60	A
$V_{RRM}$		100	V
$I_{FRM}$	$T_C = 139\text{ °C}$ (per leg)	60	A
$I_{FSM}$	$t_p = 5\ \mu\text{s}$ sine	1500	
$V_F$	30 Apk, $T_J = 125\text{ °C}$	0.69	V
$T_J$	Range	- 65 to 175	°C

### VOLTAGE RATINGS

PARAMETER	SYMBOL	63CTQ100GPbF	UNITS
Maximum DC reverse voltage	$V_R$	100	V
Maximum working peak reverse voltage	$V_{RWM}$		

### ABSOLUTE MAXIMUM RATINGS

PARAMETER	SYMBOL	TEST CONDITIONS	VALUES	UNITS
Maximum average forward current per leg per device	$I_{F(AV)}$	50 % duty cycle at $T_C = 139\text{ °C}$ , rectangular waveform	30	A
			60	
Peak repetitive forward current per leg	$I_{FRM}$	Rated $V_R$ , square wave, 20 kHz, $T_C = 140\text{ °C}$	60	
Maximum peak one cycle non-repetitive surge current per leg	$I_{FSM}$	5 $\mu\text{s}$ sine or 3 $\mu\text{s}$ rect. pulse	1500	
		10 ms sine or 6 ms rect. pulse	300	
Non-repetitive avalanche energy per leg	$E_{AS}$	$T_J = 25\text{ °C}$ , $I_{AS} = 0.75\text{ A}$ , $L = 40\text{ mH}$	11.25	mJ
Repetitive avalanche current per leg	$I_{AR}$	Current decaying linearly to zero in 1 $\mu\text{s}$ Frequency limited by $T_J$ maximum $V_A = 1.5 \times V_R$ typical	0.75	A

\* Pb containing terminations are not RoHS compliant, exemptions may apply



ELECTRICAL SPECIFICATIONS						
PARAMETER	SYMBOL	TEST CONDITIONS		TYP.	MAX.	UNITS
Maximum forward voltage drop	$V_{FM}^{(1)}$	30 A	$T_J = 25\text{ }^\circ\text{C}$	0.78	0.82	V
		60 A		0.94	1.0	
		30 A	$T_J = 125\text{ }^\circ\text{C}$	0.64	0.69	
		60 A		0.78	0.83	
Maximum instantaneous reverse current	$I_{RM}$	$T_J = 25\text{ }^\circ\text{C}$	$V_R = \text{Rated } V_R$	0.02	0.3	mA
		$T_J = 125\text{ }^\circ\text{C}$		11	20	
Maximum junction capacitance	$C_T$	$V_R = 5\text{ }V_{DC}$ (test signal range 100 kHz to 1 MHz) $25\text{ }^\circ\text{C}$		1100		pF
Typical series inductance	$L_S$	Measured from top of terminal to mounting plane		8.0		nH
Maximum voltage rate of change	$dV/dt$	Rated $V_R$		10 000		V/ $\mu\text{s}$

**Note**(1) Pulse width < 300  $\mu\text{s}$ , duty cycle < 2 %

THERMAL - MECHANICAL SPECIFICATIONS				
PARAMETER	SYMBOL	TEST CONDITIONS	VALUES	UNITS
Maximum junction and storage temperature range	$T_J, T_{Stg}$		- 65 to 175	$^\circ\text{C}$
Maximum thermal resistance, junction to case per leg	$R_{thJC}$	DC operation	1.2	$^\circ\text{C/W}$
Typical thermal resistance, case to heatsink	$R_{thCS}$	Mounting surface, smooth and greased	0.50	
Approximate weight			2	g
			0.07	oz.
Mounting torque	minimum	Non-lubricated threads	6 (5)	kgf · cm
	maximum		12 (10)	(lbf · in)
Marking device		Case style TO-220AB	63CTQ100G	

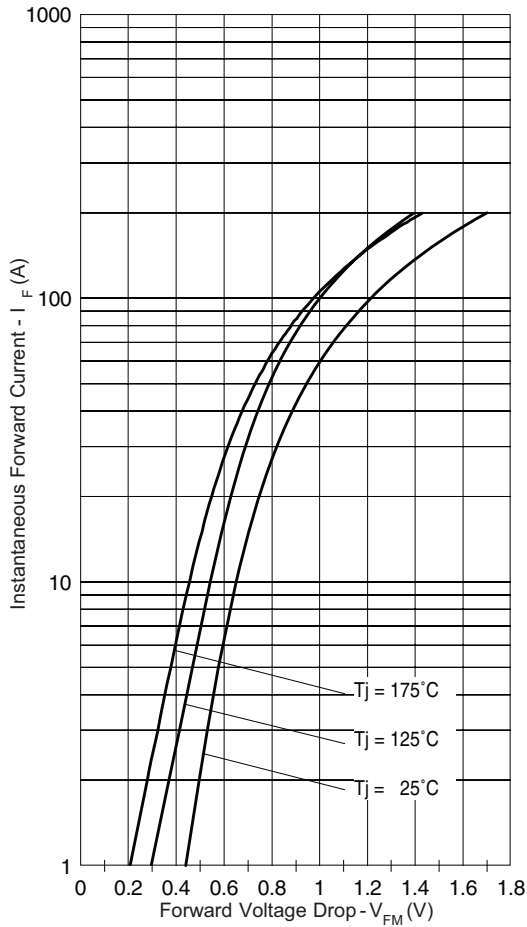

Fig. 1 - Maximum Forward Voltage Drop Characteristics

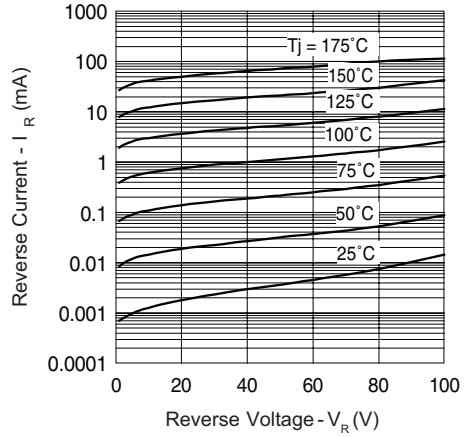

Fig. 2 - Typical Values of Reverse Current vs. Reverse Voltage

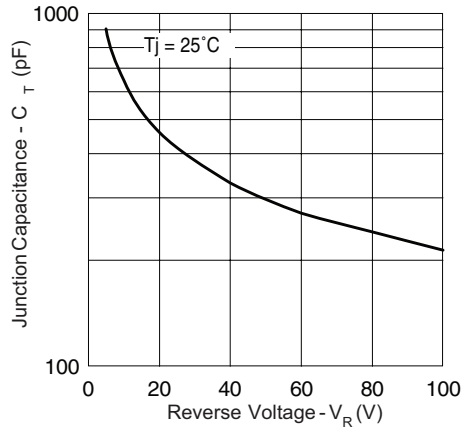

Fig. 3 - Typical Junction Capacitance vs. Reverse Voltage

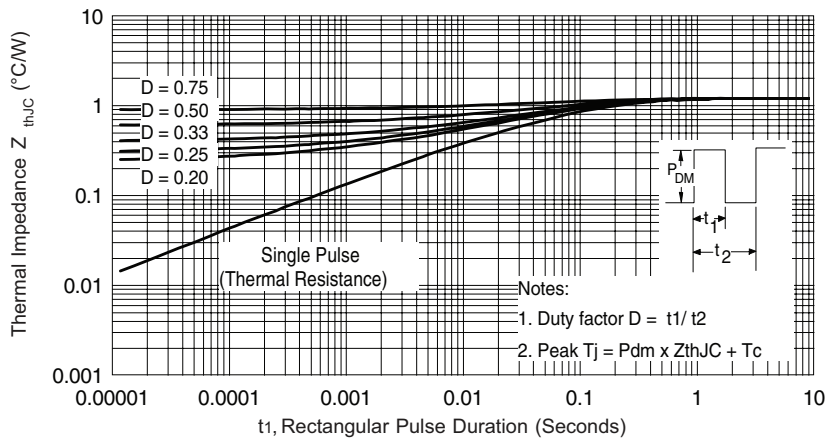

Fig. 4 - Maximum Thermal Impedance  $Z_{thJC}$  Characteristics

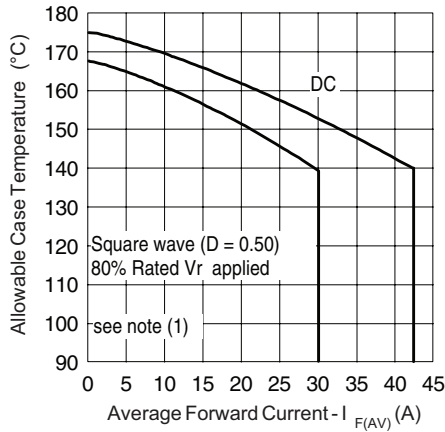

Fig. 5 - Maximum Allowable Case Temperature vs. Average Forward Current

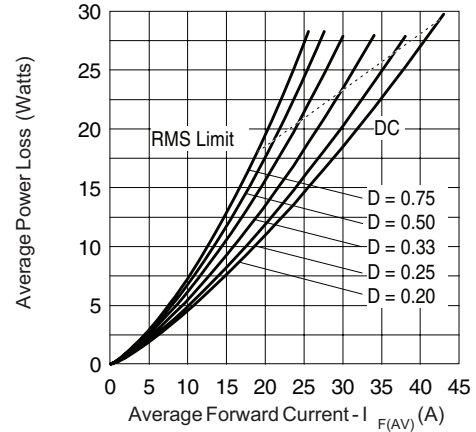

Fig. 6 - Forward Power Loss Characteristics

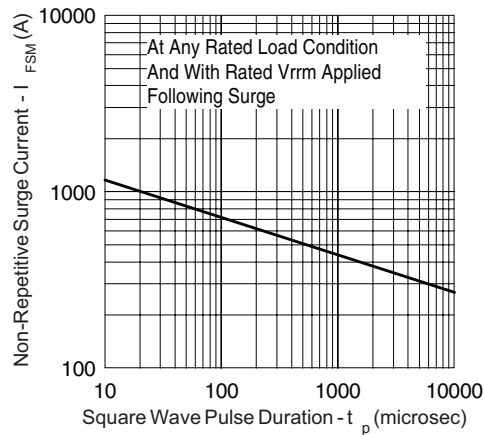

Fig. 7 - Maximum Non-Repetitive Surge Current (Per Leg)

**Note**

- (1) Formula used:  $T_C = T_J - (P_d + P_{d_{REV}}) \times R_{thJC}$ ;  
 $P_d$  = Forward power loss =  $I_{F(AV)} \times V_{FM}$  at  $(I_{F(AV)}/D)$  (see fig. 6);  
 $P_{d_{REV}}$  = Inverse power loss =  $V_{R1} \times I_R (1 - D)$ ;  $I_R$  at  $V_{R1} = 80\%$  rated  $V_R$



**ORDERING INFORMATION TABLE**

Device code	<b>63</b>	<b>C</b>	<b>T</b>	<b>Q</b>	<b>100</b>	<b>G</b>	<b>PbF</b>
	①	②	③	④	⑤	⑥	⑦
<b>1</b>	-	Current rating (60 A)					
<b>2</b>	-	C = Common cathode					
<b>3</b>	-	T = TO-220					
<b>4</b>	-	Q = Schottky "Q" series					
<b>5</b>	-	Voltage rating (100 = 100 V)					
<b>6</b>	-	G = Schottky generation					
<b>7</b>	-	• None = Standard production • PbF = Lead (Pb)-free					

Tube standard pack quantity: 50 pieces

LINKS TO RELATED DOCUMENTS	
Dimensions	<a href="http://www.vishay.com/doc?95222">http://www.vishay.com/doc?95222</a>
Part marking information	<a href="http://www.vishay.com/doc?95225">http://www.vishay.com/doc?95225</a>



## Disclaimer

All product specifications and data are subject to change without notice.

Vishay Intertechnology, Inc., its affiliates, agents, and employees, and all persons acting on its or their behalf (collectively, "Vishay"), disclaim any and all liability for any errors, inaccuracies or incompleteness contained herein or in any other disclosure relating to any product.

Vishay disclaims any and all liability arising out of the use or application of any product described herein or of any information provided herein to the maximum extent permitted by law. The product specifications do not expand or otherwise modify Vishay's terms and conditions of purchase, including but not limited to the warranty expressed therein, which apply to these products.

No license, express or implied, by estoppel or otherwise, to any intellectual property rights is granted by this document or by any conduct of Vishay.

The products shown herein are not designed for use in medical, life-saving, or life-sustaining applications unless otherwise expressly indicated. Customers using or selling Vishay products not expressly indicated for use in such applications do so entirely at their own risk and agree to fully indemnify Vishay for any damages arising or resulting from such use or sale. Please contact authorized Vishay personnel to obtain written terms and conditions regarding products designed for such applications.

Product names and markings noted herein may be trademarks of their respective owners.